

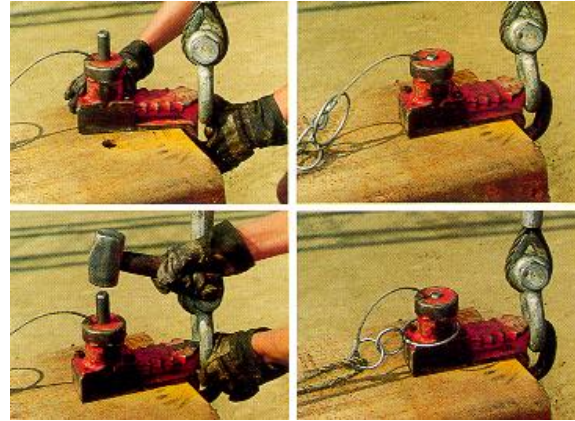

## Ground Release Shackles

The Euro style ground release shackle makes it simple to safely and easily loft steel H-beams, pipe and sheet pile.

Simply position the pin over the pin hole and strike the shackle pin. When the pin is flush with the housing the shackle is fully engaged. Place the safety ring over the housing and the pile is ready for lofting.



After positioning and securing the pile, release the safety ring by flipping the release line. Then pull on the release cable to free the shackle from the pile.

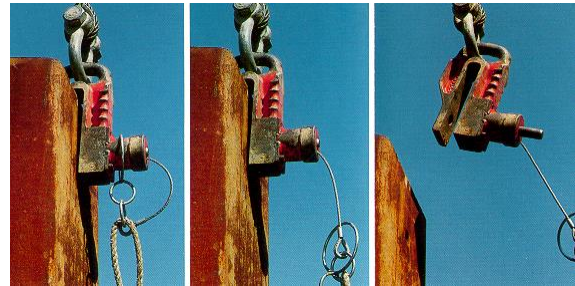

Several sizes and capacities are available:

Model	A	B	C	Capacity	Weight
<b>5983A</b>	<b>6</b>	<b>1.18</b>	<b>0.87</b>	<b>4 Tons</b>	<b>40</b>
5984A	6	1.18	1.10	8 Tons	40
5985A	6	1.18	1.38	11 Tons	40
<b>5992</b>	<b>6</b>	<b>1.37</b>	<b>1.38</b>	<b>11 Tons</b>	<b>40</b>
<b>5986A</b>	<b>10</b>	<b>1.18</b>	<b>1.10</b>	<b>8 Tons</b>	<b>48</b>
<b>5987A</b>	<b>10</b>	<b>1.18</b>	<b>1.38</b>	<b>11 Tons</b>	<b>48</b>

Ratchet release styles are also available:

Model	A	B	C	Capacity	Weight
689A	6	1.18	1.06	8 Tons	31
687A	6	1.18	1.38	11 Tons	31
686A	10	1.18	1.06	8 Tons	40
<b>688A</b>	<b>10</b>	<b>1.18</b>	<b>1.38</b>	<b>11 Tons</b>	<b>40</b>
<b>693A</b>	<b>12</b>	<b>1.18</b>	<b>1.38</b>	<b>11 Tons</b>	<b>51</b>
<b>6961A</b>	<b>10</b>	<b>2.13</b>	<b>2.40</b>	<b>27 Tons</b>	<b>106</b>
<b>6962A</b>	<b>10</b>	<b>2.00</b>	<b>2.40</b>	<b>44 Tons</b>	<b>148</b>

All measurements are in inches and all weights are in pounds.  
Bold items are typically stocked items.

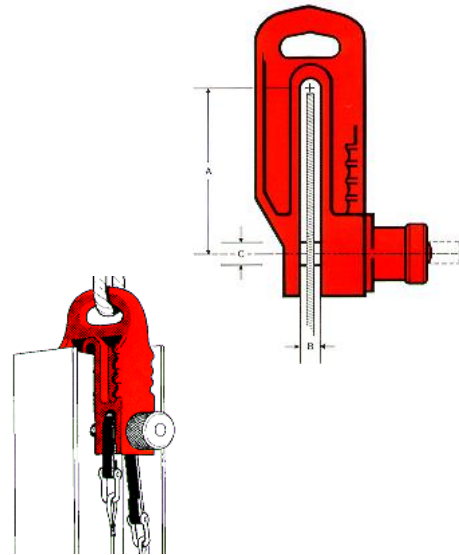

## Bay Machinery Corporation

543 S. 8<sup>th</sup> St.

Richmond, Ca. 94804

Phone: 510/236-9000

# Keep the Men on the Ground!

## Ground Release Shackle Applications

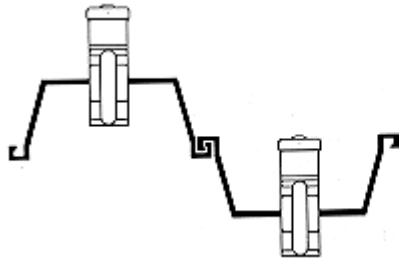

Sheet Piles

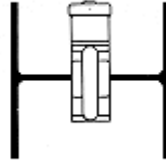

H-Beams

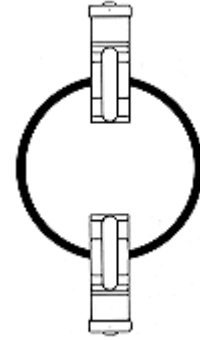

Pipe Pile

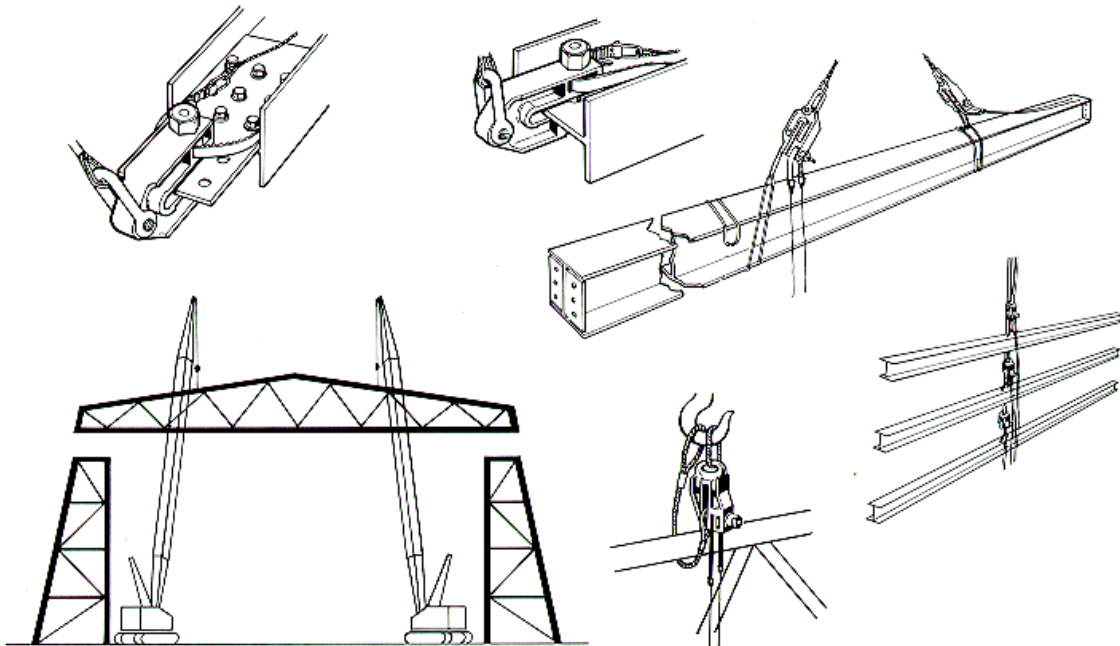

Long and Irregular Shapes

## Bay Machinery Corporation

543 S. 8<sup>th</sup> Street  
Richmond, Ca. 94804

**Phone: 510/236-9000**  
Fax: 510/236-7212